

3 GATES - RH UNIT

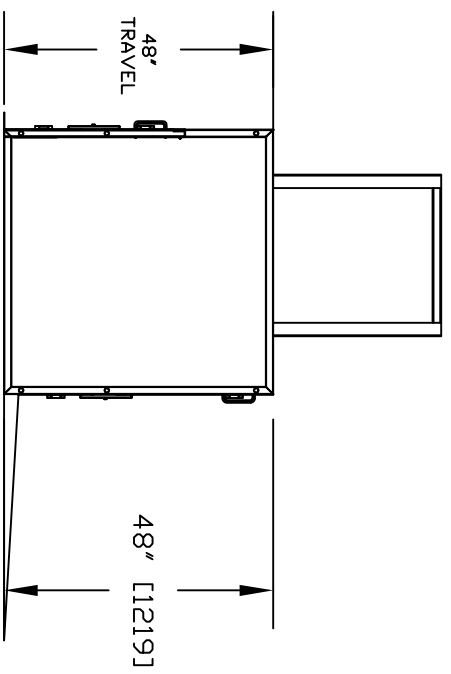

RH UNIT SHOWN

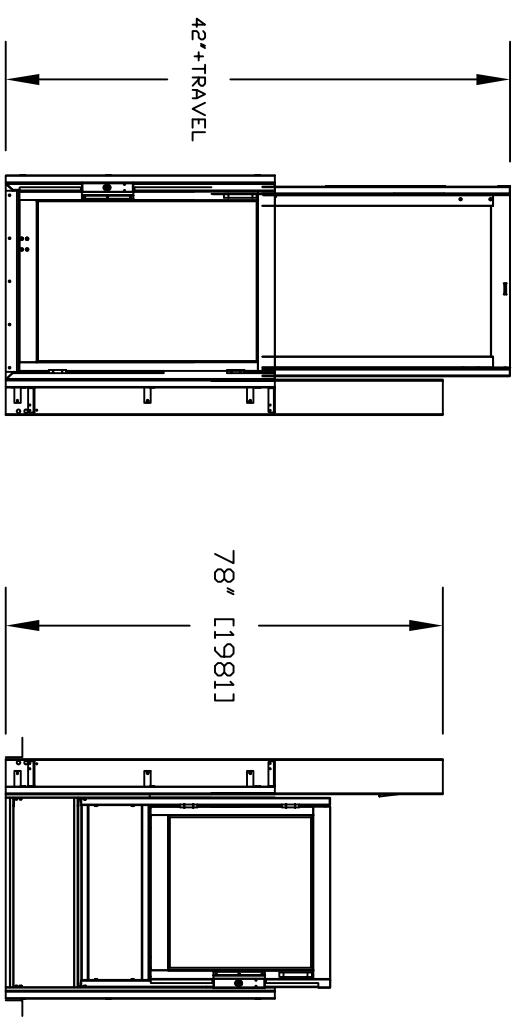
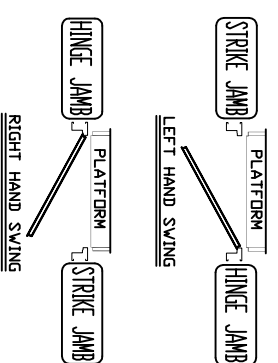
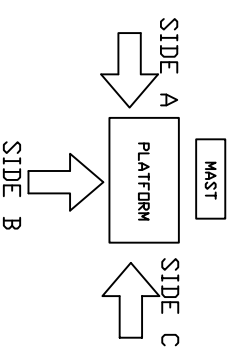
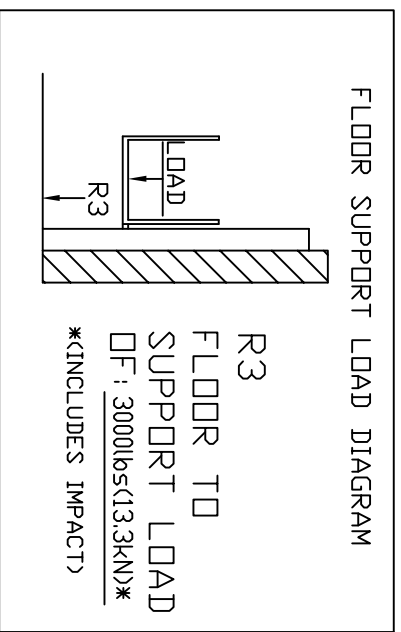

TOP VIEW TYPE-2

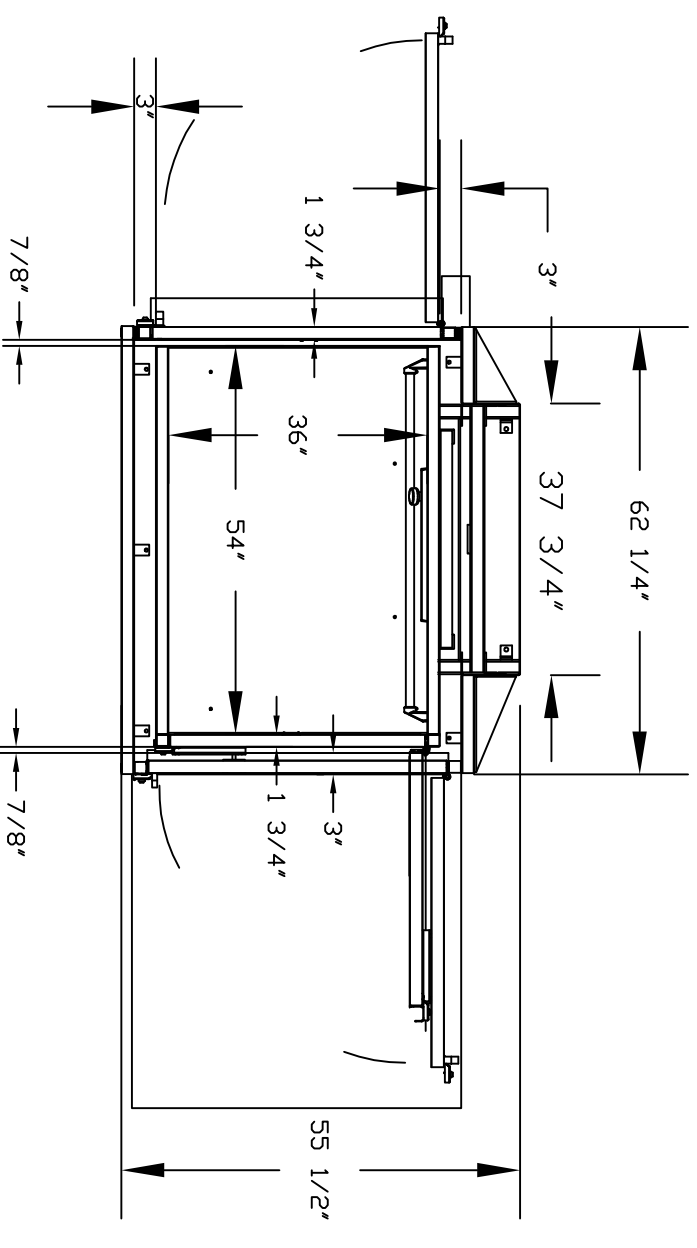

TYPICAL PLAN

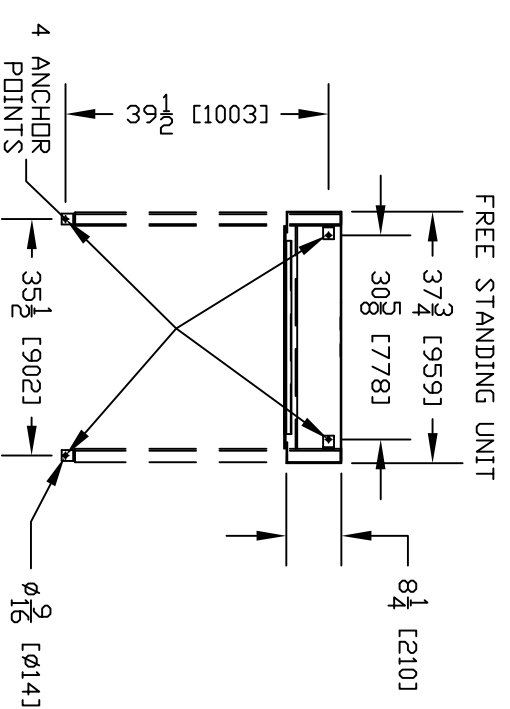

GENERAL ARRANGEMENT
VERTICAL WHEELCHAIR PLATFORM LIFT

CUSTOMER:	DATE:	Part No.	3 GATES
PROJECT:	REVISION DATE:	Variant No.	
ADDRESS:	COMPLETED BY:		
		JOB No.	SHEET No.

ERROR: syntaxerror
OFFENDING COMMAND: --nostringval--

STACK:

/Title
()
/Subject
(D:20150114081652-05'00')
/ModDate
()
/Keywords
(PDFCreator Version 0.9.5)
/Creator
(D:20150114081652-05'00')
/CreationDate
(phillip)
/Author
-mark-