

# 3 GATES - LH UNIT

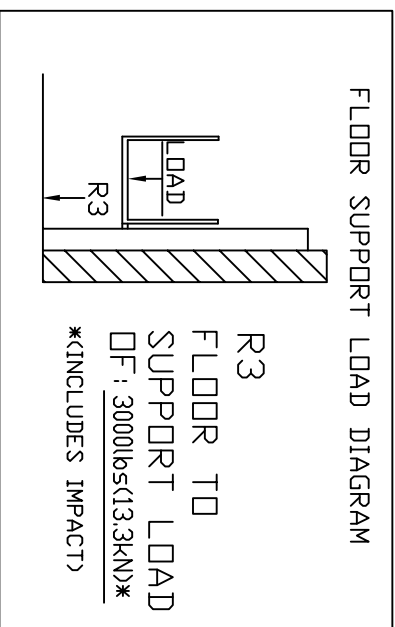

## TYPICAL PLAN

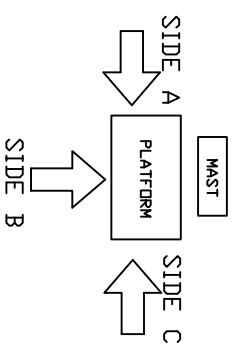
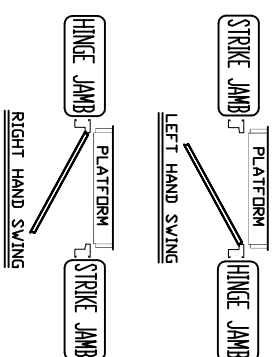
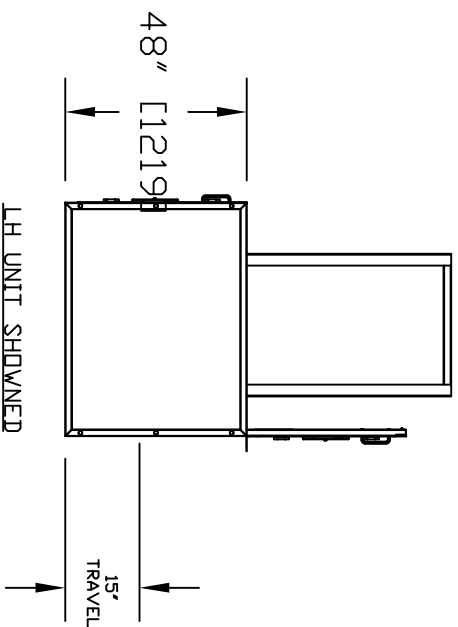
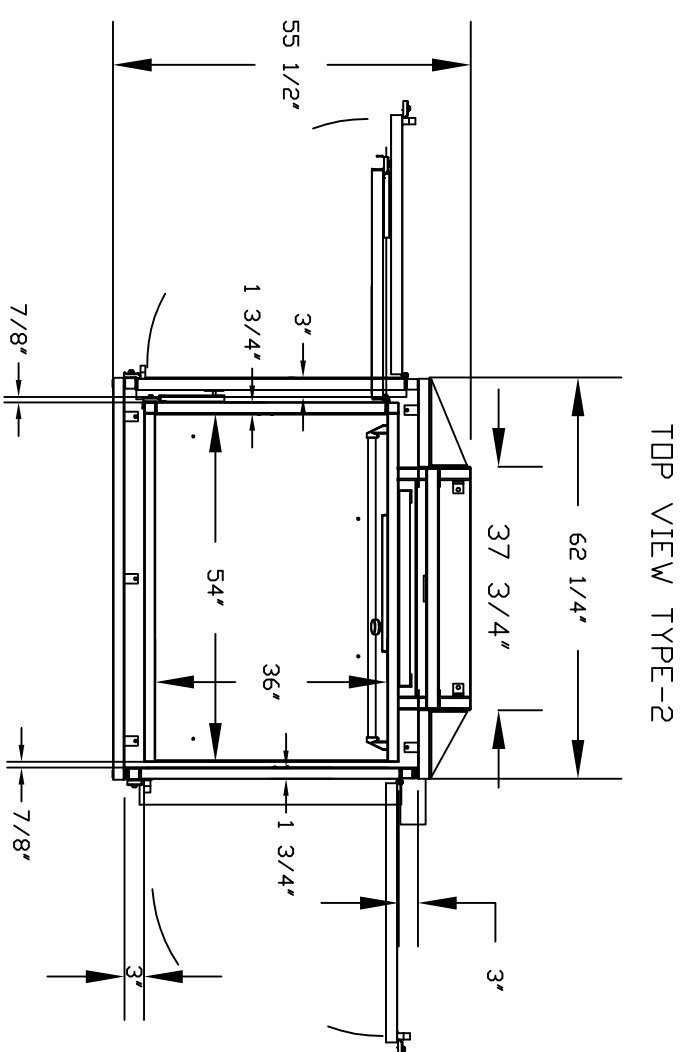
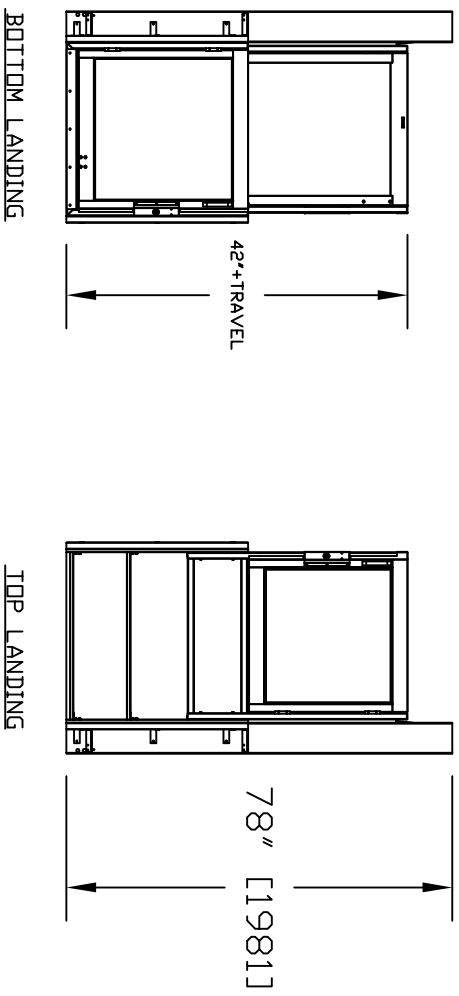
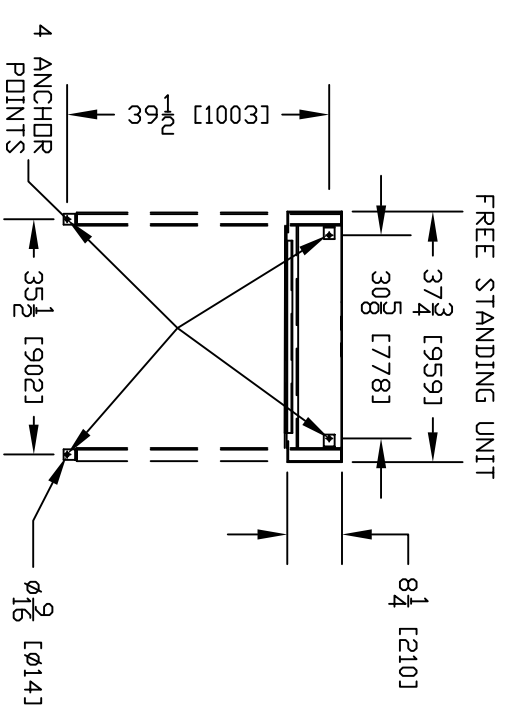

GENERAL ARRANGEMENT  
VERTICAL WHEELCHAIR PLATFORM LIFT

CUSTOMER:  
PROJECT:  
ADDRESS:

DATE:  
REVISION DATE:  
COMPLETED BY:

Part No. 3 GATES  
Variant No.

**savarida**

JOB No.

SHEET No.



ERROR: syntaxerror  
OFFENDING COMMAND: --nostringval--

STACK:

/Title  
( )  
/Subject  
(D:20150114081508-05'00')  
/ModDate  
( )  
/Keywords  
(PDFCreator Version 0.9.5)  
/Creator  
(D:20150114081508-05'00')  
/CreationDate  
(phillip)  
/Author  
-mark-